

TSD Coils

平滑用 鉄合金系ダストチョークコイル
Silicon Steel Dust Choke Coil for Smoothing



特長

- コアロスが非常に低い為、PFC 等の電源の効率向上に有利。
- 磁歪定数が小さい材料を使用していますので、唸り音対策に有利。

FEATURES

- It has advantageous to efficiency-enhancing power circuit in PFC and so on, as the core loss is low.
- It has advantageous to countermeasure for vibration noise, as magnetostriction constant is low.

用途

- スイッチング電源出力平滑用。
- 高調波対策アクティブフィルタ用。
- DC-DC コンバータ用。
- ノーマルモードラインフィルタ用。
- テレビ・オーディオ等のノイズ防止用。ほか

APPLICATIONS

- For smoothing switching power supplies output.
- For active filter for harmonic suppressor.
- For DC-DC converter.
- For normal mode line filter.
- For noise prevention of TV, audio device etc.

外形寸法図 (mm)

DIMENSIONS (mm)

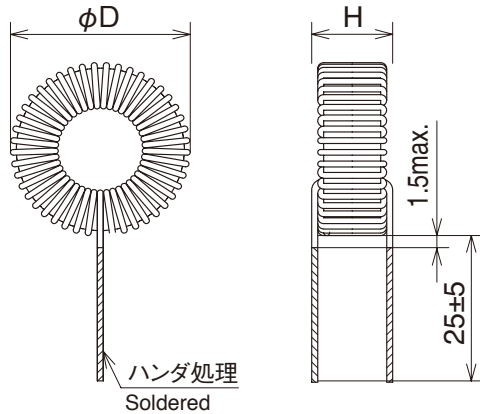

TSDコイル標準仕様 Standard Specifications

カタログ品番 Name	定格電流 Rated current Idc (A)	インダクタンス (μH) Inductance (μH)		直流抵抗 D. C. R (mΩ) MAX	線径 Wire dia (φmm)	外形寸法 Dimensions D×H (mm) MAX	推奨台座 Recommended base
		Idc=0(A)	Idc=Rated				
TSD-05-0030	5	41	30	25	1.0	23×14	No.227
TSD-05-0055		74	55	34		28×15	No.274
TSD-05-0160		255	160	70		34×18	No.217
TSD-05-0200		390	200	85		34×19	No.275
TSD-05-0280		480	280	95		34×24	No.275
TSD-05-0500		920	500	120		41×28	No.275
TSD-08-0110	8	190	110	36	1.3	35×24	No.275
TSD-08-0260		480	260	62		45×26	No.163
TSD-08-0490		1000	490	100		51×35	No.265
TSD-10-0030	10	45	30	12	1.1×2	35×19	No.217
TSD-10-0095		155	95	24		41×26	No.275
TSD-10-0150		255	150	30		45×27	No.163
TSD-10-0300		580	300	55		51×34	No.265
TSD-15-0075	15	128	75	17	1.3×2	45×27	No.163
TSD-15-0140		290	140	27		51×35	No.265
TSD-20-0011	20	14	11	4.2	1.1×4	35×23	No.275
TSD-20-0022		30	22	6		40×27	No.275
TSD-20-0090		220	90	16		53×35	No.265

(1) インダクタンス測定条件:100kHz
 (2) 使用電線:1PEW
 (3) ケース難燃性:UL-94V-0
 (4) インダクタンス公差:Idc=定格時±25%、Idc=0(A)時は参考値
 (5) 台座をご使用になる場合は巻線の線径や本数を変更する場合がございますので予めご了承下さい。

(1) Inductance measurement condition : 100kHz
 (2) Used wire : 1PEW
 (3) Case incombustibility : UL-94V-0
 (4) Inductance tolerance : Idc=rated time ±25% Idc=0 (A) is a reference value
 (5) Note that when using the base, the wire diameter and / or the number of wires may be changed in some cases.

TSD Coils

平滑用 鉄合金系ダストチョークコイル
Silicon Steel Dust Choke Coil for Smoothing



TSD COILS 直流重畳特性 (代表例) DC BIAS <Example>

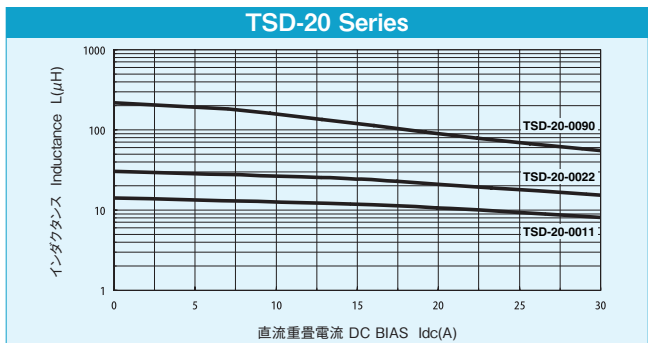
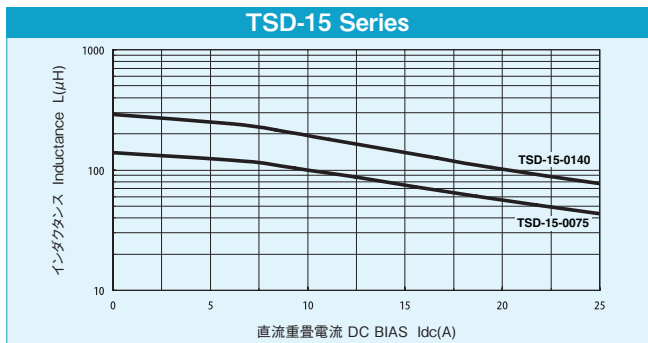
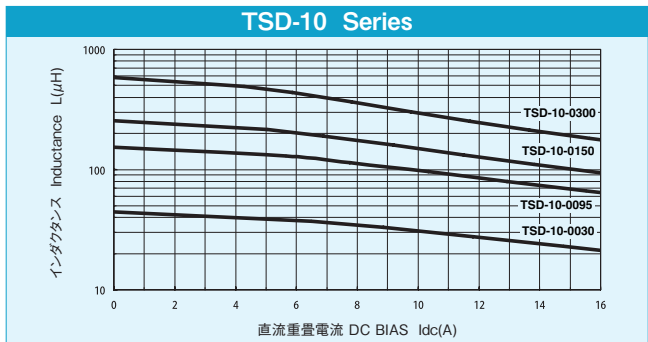
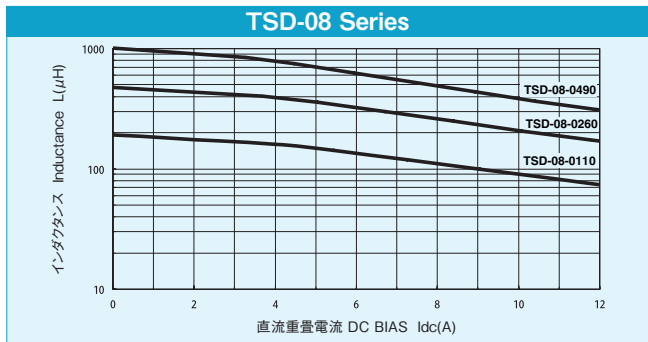
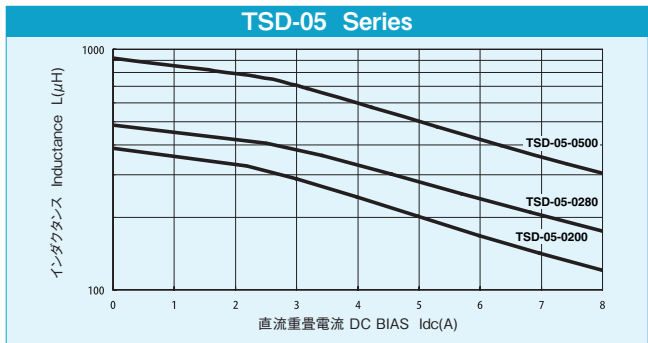
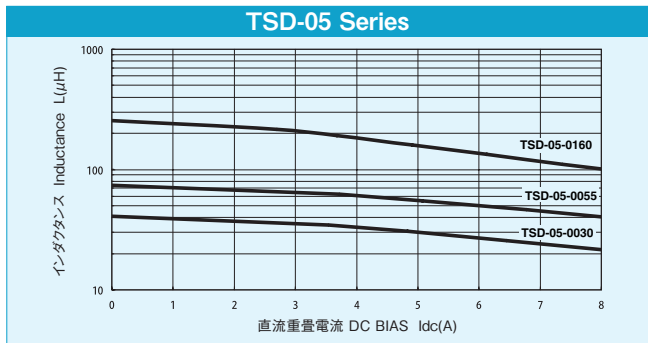

※1 測定周波数:100kHz
Measurement Frequency :100kHz